

Operating manual
BlueMax Mini Type 2/6

en

Contents

1. Foreword		
1. Introduction	37	
2. Important notes	37	
Revision service	37	
Updating	37	
3. Validity of this operating manual	37	
Application	37	
Copyright reserved	37	
4. Owner's personal responsibility	37	
5. Service	37	
2. EC declaration and protocols		
1. EC Declaration of Conformity	38	
2. Important note	39	
3. Verification of instruction	39	
3. General safety rules		
1. Basics	40	
Information for operating personnel	40	
2. General	41	
3. Safety advice for the user company	42	
4. Noise	42	
5. Oils, greases and other chemical substances	42	
6. Residual risk	42	
7. Safety advice for operating personnel	42	
8. Safety advice for operating the machine	43	
9. Safety advice for carrying out maintenance work	43	
10. Training / instruction	43	
11. Personal protective equipment	43	
4. Description of the machine		
1. Technical specifications	44	
2. Controls	45	
3. Setting up	45	
4. Rating plate	45	
5. Safety guards	45	
6. Labelling	45	
Area: motor	46	
5. Transportation and installation		
1. Transportation	48	
2. Internal transportation	48	
3. Checking delivery for missing items	49	
4. Dealing with shipping damage	49	
5. Site of installation	49	
6. Start up		
1. General	50	
2. Safety check	50	
3. Malfunctions on start up	51	
4. Starting up for the first time	51	
5. Carrying out trial run	51	
6. Concluding start up	51	
7. Operation		
1. Preparing machine	52	
Drilling spindles	52	
Drill bits	53	
Connecting to extractor system	53	
Connecting to the power supply	53	
Accessories	53	
Support block	53	
2. Setting up (preparing for work)	54	
Setting drilling depth	54	
Edge distance	54	
Pendulum stops	54	
3. Operating	54	
4. Installing Hettich hinges	55	
Setting up	55	
Drilling	55	
5. Installing Hettich mounting plates	56	
Setting up	56	
Drilling	56	
6. Installing Hettich connecting fittings	57	
Setting up	57	
Drilling	57	
8. Malfunctions / troubleshooting		
1. General information	58	
2. Servicing and maintenance	58	
3. Labelling, information signs	58	
4. Taking out of service	59	
5. Disposal	59	
Protecting the environment	59	
Scrapping	59	
Oil and oily wastes	59	
9. Replacement and expendable parts	60	
Exploded drawing	61	

1. Foreword

1. Introduction	37
2. Important notes	37
Revision service	37
Updating	37
3. Validity of this operating manual	37
Application	37
Copyright reserved	37
4. Owner's personal responsibility	37
5. Service	37



WARNING

Read these operating instructions carefully in order to obtain a thorough understanding of the machine and how to handle and maintain it. Operate the machine in the proper manner as described in these instructions so as to avoid injury and damage to the system. Do not operate the machine on the basis of suppositions. Keep these operating instructions to hand and consult them if you are in any doubt as to carrying out any particular procedure.

If any questions remain unanswered after reading through the instructions, you must not put the machine into operation. Settle any unanswered questions first by consulting **Paul Hettich GmbH & Co. KG.**

These operating instructions are intended to make it easier for you to become familiarised with the machine and use its capabilities in the proper manner. The operating instructions contain important information on operating the machine in a safe, proper and cost effective manner. Following them will help to avoid hazards, repair costs and down times, enhance reliability and prolong service life.

Existing national regulations on preventing accidents and on protecting the environment are also applicable.

The machine must only be assembled and installed by persons instructed to do so by Paul Hettich GmbH & Co. KG. This also applies in particular to starting it up for the first time.

The operating instructions must be available at the machine all the time. The operating instructions must be read and applied by any person entrusted with working with / on the machine, e.g.:

- Operation
- including setting up, troubleshooting while working, disposal of production waste, care, disposing of consumables and auxiliary substances,
- Maintenance
- Servicing, inspection, repair
- Handling

1. Introduction

The main objective of this operating manual is to protect "man and machine" in accordance with the EC Machinery Directives. It is intended for all persons involved in working with and on this machine or system, in particular the operating personnel.

- As operating / servicing personnel, first read this operating manual and familiarise yourself with using the machine and operating it safely as well as with how to perform the necessary set-up, servicing and / or repair work in the proper way while meeting the safety requirements
- Your personal safety and that of your surroundings as well as safe machine operation without risk to other property or the environment will only be ensured if you are familiar with and follow all of the information in this operating manual as well as in pertinent health and safety regulations
- As customer and / or owner, make sure that this operating manual is given to your operating / servicing personnel before putting the machine / system into service for the first time, that it remains available directly at the machine at all times and that all persons concerned observe the information and warnings provided in this operating manual, the code of practice applicable to the site of installation as well as the regulations on occupational health and safety etc.

In other words, this operating manual does not release the owner from the duty to devise his or her own health and safety rules as well as safe work procedures tailored to his or her production requirements / needs, to any specific system / machine combination, to specific installation conditions, to specific modes of connection and/or tool and component properties etc., and to apply these, have them applied and monitor their observance

2. Important notes

Revision service

This operating manual is not subject to any revision service. If changes / additions are made after the machine has been delivered, it is the responsibility of the owner to update this operating manual using his or her own addenda or any addenda provided by Paul Hettich GmbH & Co. KG.

The right is at all times reserved to amend and improve all technical specifications, details and illustrations in the interest of technical progress.

Updating

The laws, provisions, regulations, directives, codes of practice etc. specified in this operating manual as well as statements derived from them were up to date at the time this manual was compiled.

They must be heeded in their latest, applicable wording, updated at the responsibility of the owner and always applied in their more restrictive (stringent) wording.

We also point out that the content of this operating manual is not part of any earlier agreement, assurance or legal relationship or intended to amend such. All obligations on the part of Paul Hettich GmbH & Co. KG arise from the pertinent supply contract that also contains the complete and solely applicable warranty arrangements or draws attention to these. Statements made in this operating manual neither extend nor restrict these warranty provisions.

3. Validity of this operating manual

- This operating manual only applies to this machine
- Please always quote the machine no. in all queries and orders for replacement parts

Statements made in this operating manual in relation to items of equipment not included with the machine are for information only. They do not give rise to any legal claim to the machine being equipped with these items.

Application

This operating manual has been produced in compliance with EC directives, European (harmonised) standards etc. References to occupational health and safety, environmental protection and safety provisions may not yet conform to harmonised accident prevention regulations (UVV) / statutory accident insurance regulations (GUV) applicable in Germany or to the DIN standards or technical regulations stated in the appendix to the German Equipment Safety Act (Gerätesicherheitsgesetz (GSG)).

The customer / owner is personally responsible for:

- regarding specified laws, regulations, directives etc., as the basis for safe handling and maintenance practice,
- implementing and observing them in line with national / regional / company-internal regulations
- providing supplementary safety or protective equipment prescribed by the responsible local, regional or national authorities and for fitting them before using the machine / system for the first time

Operating manual: Paul Hettich GmbH & Co. KG© 2017

Copyright to the operating instructions

The copyright to this operating manual remains with **Paul Hettich GmbH & Co. KG.**

These operating instructions are intended for the operating personnel. They contain regulations and drawings of a technical nature that must not be duplicated either in whole or in part, distributed, used without permission for advertising purposes or communicated to others.

Reproduction either in whole or in part is not permitted.

4. Owner's personal responsibility

The customer or owner is personally responsible for ensuring that

- provisions on occupational health and safety, environmental protection and disposal are observed in relation to the machine, handling it as well as in the course of inspections, servicing and repair measures
- no improper changes or modifications are made to the machine or safety guards
- the machine is not used in any inappropriate, improper or non-intended manner
- Intended use also includes following the prescribed operating, servicing and maintenance conditions.

5. Service

Customer Service

Paul Hettich GmbH & Co. KG,
Vahrenkampstrasse 12 - 16, D-32278 Kirchlengern

EC declaration and protocols

2. EC declaration and protocols

- | | |
|---------------------------------|----|
| 1. EC Declaration of Conformity | 38 |
| 2. Important note | 39 |
| 3. Verification of instruction | 39 |

1. EC Declaration of Conformity

EC Declaration of Conformity is enclosed loose.

2. Important note

Information for the owner

In addition to these operating instructions and the accident prevention regulations in force in the country of use or at the place of application, it is also necessary to follow the recognised code of safe and proper working practice.

Without the consent of Paul Hettich GmbH & Co. KG, the machine owner must not make any additions, alterations or modifications to the machine that may affect safety.

Replacement parts used must meet the technical requirements defined by Paul Hettich GmbH & Co. KG. This is always ensured when using genuine replacement parts from the applicable replacement parts list.

Only ever deploy trained or instructed personnel and clearly define personnel responsibilities with regard to operating, servicing and repair.

Use for other purposes and modifications

We expressly point out that the EC declaration shall become null and void if modifications / changes etc. are made to the machines listed above. The company making the modification must amend the EC declaration and extend or make out new documentation to reflect the latest modification. (Art. 8 (6) of the EC Machinery Directive)

3. Verification of instruction

By signing this protocol the undersigned confirms that the following details and specifications are correct.

Confirmation

I hereby confirm that I have read and understood the operating manual for the machine:

Designation **BlueMax Mini Type 2/6**

Type **Automatic drilling unit**

Machine no.

I furthermore undertake to observe and follow the general safety precautions, the servicing and care instructions as well as power-up and operating instructions and the provisions relating to malfunctions. I am aware that any failure to observe these instructions and provisions may lead to accidents, put persons at risk and result in damage to property and the machine.

en

Name		Date from / to	Type of instruction received			Signature of the person having received instruction
Instructor	Person instructed		Operation	Safety rules	Servicing	

General safety rules

3. General safety rules

- 1. Basics 40
 - Information for operating personnel 40
- 2. General 41
- 3. Safety advice for the user company 42
- 4. Noise 42
- 5. Oils, greases and other chemical substances 42
- 6. Residual risk 42
- 7. Safety advice for operating personnel 42
- 8. Safety advice for operating the machine 43
- 9. Safety advice for carrying out maintenance work 43
- 10. Training / instruction 43
- 11. Personal protective equipment 43

1. Information on signs, symbols and markings

The safety advice in the operating instructions is structured as follows:



DANGER

This danger advice draws attention to an **immediately** dangerous situation that **will** lead to **death** or **serious injuries** if the safety measures are not followed.



WARNING

This danger note draws attention to a **potentially** dangerous situation that **may** lead to **death** or **serious injuries** if the safety measures are not followed.



CAUTION

This danger note draws attention to a **potentially** dangerous situation that **may** lead to **minor** or **slight injuries** if the safety measures are not followed.



NOTE

This advice draws attention to **potential damage to property** or to a **process of particular interest / importance** that may occur if the safety measures are not followed.

In the operating instructions, hazard points are identified as follows:



DANGER

Danger from electric shock!

Working on live components in the improper manner presents a danger to life!

Work on electrical equipment must only be carried out by authorised electricians!



WARNING

Hearing damage warning!

Some areas of the facility can reach noise levels of over 80 dB (A).

Wear ear protectors when working in noisy areas!



WARNING

Danger from wood dust!

Wood dust can affect the respiratory tract. For this reason, wear a dust protection mask.



WARNING

Fire risk!

Grinding and welding work must never be performed on this machine.

Follow welding regulations and accident prevention regulations.



WARNING

Explosion protection!

Machine is not explosion-protected. Do not install near paint shops.



WARNING

Warning - Hand injuries!

Hands could be crushed, drawn in or otherwise injured.

Never reach into the system's moving parts!

Wear hand protection!



WARNING

Warning - Hot surfaces / objects!

There is a risk of injury from touching hot surfaces (e.g. electric motors).

Do not touch!

2. General

The machine described in the operating instructions is built to the state of the art and safe to operate. It complies with DIN EN 12100.

Hazard zones are made safe in compliance with the regulations. However, the machine may present hazards if it is used by untrained personnel improperly or not for the intended purpose.

This may then result in risks to life and limb, jeopardise the machine and prevent it from working efficiently.

Any person given the task of installing, starting, operating, servicing or repairing the machine at the user's premises must have read and understood these instructions, in particular the section on "Safety precautions".

In his or her own interest, the safety officer at the user company should obtain written confirmation from operating personnel that they have received instruction and training and are familiar with all safety precautions before they use the machine for the first time.

The safety guards must never be removed or taken out of operation.

If safety guards need removing for maintenance and repair work, they must be refitted as soon as such work has been completed.

The machine must only be used if it is in proper working order and operated by trained, authorised personnel.

Work requiring specialised knowledge (e.g. electrical, pneumatic system) must only be carried out by persons specifically trained and suitable to do so.

Before attempting any work on the machine, turn the main switch to the „0“ position (OFF), make the machine safe and disconnect from the compressed air supply.

Switch off energy sources before carrying out repair, servicing, installation or cleaning work.

Energy sources:

- Electrical energy
- Pneumatic energy



CAUTION

Danger from residual energy!

Stored energy will not be dissipated even after switching the system off at the main switch.

Dissipate residual or stored energy!

Switch off / dissipate energy sources:

For safety regulations applicable to third party devices, refer to the documentation from the third party manufacturers (operating instructions for bought in units).

Electrical energy via the motor switch / machine's main switch. Additionally attach a notice when servicing or other work is being carried out on the machine.

en



Fig. 2: Main switch

General safety rules

3. Safety advice for the user company

All persons entrusted with operating the machine (including line managers) must familiarise themselves with the section on "Safety advice". The safety advice must be followed.

The machine must only be used if it is in proper working order. The user company will issue clear responsibilities, e.g. for servicing, cleaning or repair, and ensure that the persons carrying out this type of work have received the training necessary for it.

The safety regulations applicable in the owner's country must also be observed. Refrain from any work that adversely affects operating safety.

The operating personnel will check the machine for changes or malfunctions, report such to the safety officer responsible and, if necessary, take the machine out of operation.

Only appropriate tools may be used for the work that needs to be done; remove tools after completing work. The place at which staff work must be selected in such a way as to ensure that work operations can be viewed at all times, the machine can always be stopped immediately and safety is never at risk.



WARNING

Never:

- reach into the machine when it is operating
- remove covers and take safety guards out of operation
- hinder unobstructed access to the controls
- continue operating the machine if changes occur that adversely affect safety
- manipulate or circumvent safety guards

4. Noise

The weighted equivalent continuous sound level is **> 85 dB (A)**.



WARNING



Hearing damage warning!

Local conditions may produce elevated sound pressure and cause noise induced hearing loss!

Operating personnel must be provided with appropriate protective equipment or be protected by other measures!

Wear ear protectors when working with the machine!

5. Oils, greases and other chemical substances

When handling oils, greases and other chemical substances, you must observe and follow the applicable regulations and safety data sheets of the manufacturers of these substances with regard to storing, handling, using and disposing of them.

When working with caustic substances, you must wear protective equipment of suitable material (safety goggles, rubber gloves, rubber boots, protective clothing).

In the event of contact with the eyes or skin, immediately rinse the area affected with copious quantities of water. Appropriate facilities (eye wash bottle, wash basin, shower) must be provided near the work area.

6. Residual risk



CAUTION

Residual hazards!

Handling the machine involves residual hazards that could not be eliminated by design measures.

Pay attention to the residual risks in the Technical Documentation!

The machine reflects the state of the art and is built in accordance with recognised safety regulations. All the same, the user or third parties may still be exposed to hazards.

The machine must be used

- for the intended purpose
- in an absolutely safe state.



WARNING

Risk of injury!

Never remove safety devices or render them ineffective by making changes to the machine!

Malfunctions presenting a safety risk must be rectified without delay!

Before attempting servicing and cleaning work, switch off the entire machine and disconnect from the compressed air supply!

7. Safety advice for operating personnel

- Work on the machine must only be carried out by instructed, skilled personnel
- Only skilled personnel who have received training or instruction must be deployed
- The generally recognised code of occupational health and safety as well as accident prevention regulations must be observed
- Please keep first aid equipment (first aid kit etc.) in easy reach
- The owner must stipulate that operating personnel are to wear personal protective equipment (safety shoes and sturdy work clothing)

Work which may be done by the operating personnel

Work which may be done by the operating personnel

- Activate, deactivate the machine
- Change drill bits
- Set the machine to component dimension
- Feed in individual parts (flat panels made of engineered wood, hinges and connecting fittings)
- Start the drilling and inserting process
- Remove finished components
- Clean the machine

Requirements on operators

The operator must organise the work environment so as to permit optimum, continuous production.

The operator must be receive instruction before commencing work for the first time and every year thereafter.

Prior to commencing work, all persons working on or at the system shall undertake to

- follow the basic regulations on health and safety at work and on accident prevention
- wear personal / workplace related protective clothing and equipment for the purpose of ensuring work safety and use such while working if they are necessary for safety reasons

Work must only be performed for which authorisation has been given. For example

- work on pneumatic equipment must only be carried out by a specialist specifically trained to do so or by instructed persons under the direction and supervision of such a specialist in accordance with the applicable technical regulations

8. Safety advice for operating the machine

- The machine must only be put into operation in a fully installed and operational state
- The machine must only be operated if all protective guards and safety related equipment, e.g. protective claddings or enclosures, are in working order and undamaged
- On putting the system into operation, the operator must make sure that all safety equipment and protective guards as well as the controls are in correct working order and free of damage
- The workplace environment must be kept clean and tidy at all times. This must be ensured by internal checks
- Immediately report any irregularities or malfunctions to the department / person responsible. If necessary, the machine must be shut down immediately and made safe

9. Safety advice for carrying out maintenance work

- Maintenance work must only be performed by the manufacturer's skilled personnel or under the manufacturer's supervision
- If the machine is completely shut down for servicing and repair work, it must be prevented from switching back on unexpectedly
- If necessary, please cordon off the maintenance zone, providing a wide safety margin!
 - Attach a warning sign

- For maintenance measures, use tools that are appropriate for the work involved
- Servicing and repair work must only be carried out by the owner's qualified personnel
- If safety devices need removing for servicing and repair work, they must be refitted and checked as soon as the work has been completed
- Always tighten screw connections that have been loosened during servicing and repair work
- At the start of work, connections and screw connectors must be cleaned of oil, operating consumables and dirt
- Make sure operating consumables and auxiliary substances as well as replaced parts are disposed of safely and in an environment friendly manner.

10. Training / instruction

- As owner, you are obliged to inform and instruct the operating personnel in respect of applicable legal and accident prevention regulations as well as the safety guards fitted. In this context, bear in mind the varying specialised qualifications of your staff
- The operating personnel must understand the instruction they are given, follow it as well as sign the documentation
- This is the only way you can be sure that operating personnel work in awareness of safety and of the hazards that are involved. As owner, you should therefore obtain written confirmation from all members of staff that they have received training/instruction
- Applying these safety measures will minimise potential hazards to such an extent that the machine can be operated safely



NOTE

All of the **safety guards in place must be checked at least once before the start of each shift to make sure that they are in place and undamaged** (visual inspection).

11. Personal protective equipment

The owner must provide the following personal protective equipment:

- Safety shoes
- Ear protection
- Safety goggles
- Dust protection mask
- Safety gloves (as necessary)

Description of the machine

4. Description of the machine

1. Technical specifications	44
2. Controls	45
3. Setting up	45
4. Rating plate	45
5. Safety guards	45
6. Labelling	45
Area: motor	46

1. Technical Specifications

Designation:	machine for drilling panel type workpieces
Machine no.:	
Year of manufacture:	
System dimensions:	
Height	630 mm
Width:	800 mm
Depth:	620 mm (with suction extractor)
Weight:	31.2 kg
max. noise level:	> 85 dB (A)

Electrics

The unit is fitted with a connection cable of approx. 3 m in length and plug (refer to table for configuration). For your own safety, please instruct a qualified electrician to connect the machine. You will find the applicable connection specifications on the rating plate on the machine.

Motor overview – BlueMax Mini Type 2/6: Requirements on the electrical power supply

Connection must only be made to an electrical system complying with VDE 0100. The electrical safety of this equipment is only guaranteed if it is connected to a protective earth conductor system that complies with regulations. It is very important to check that this basic safety requirement is met and that the machine is provided with adequate fuse protection. The manufacturer cannot be held responsible for damage caused by a lacking or interrupted protective earth conductor. The rating plate provides information on rated input and the appropriate fuse protection.

Suction extractor

It is compulsory to use a flexible, fire retardant hose for connection to an extractor system. A suction extraction line is not included.

- Outside diameter (suction connector) 50 mm
- Volumetric flow 141 m³/h
- Static negative pressure at 20 m/s 1,300 Pa



NOTE

For further Technical Specifications, refer to the documentation provided by the manufacturers. Unauthorised changes and modifications to the system are not permitted for safety reasons and rule out any liability on the part of the manufacturer for any resultant damage.

Art. No.	Volts	Hertz	Phases	Rotational speed	Power	Connection
020 261	110	60	1	3,300 rpm	0.8 kW	without plug
020 262	230	60	1	3,300 rpm	0.8 kW	without plug
020 263	230	60	3	3,300 rpm	0.8 kW	without plug
020 264	230	50	1	2,800 rpm	0.8 kW	Right angle plug
020 482	230	60	1	3,300 rpm	0.8 kW	Right angle plug
020 265	230	50	3	2,800 rpm	0.8 kW	CEE plug 16 AH
020 483	230	60	3	3,300 rpm	0.8 kW	CEE plug 16 AH
020 266	230	50	1	2,800 rpm	0.8 kW	with AUS/NZL plug
020 484	230	60	1	3,300 rpm	0.8 kW	with AUS/NZL plug
020 690	400	50	3	2,800 rpm	0.8 kW	CEE plug 16 AH
020 267	400	60	3	3,300 rpm	0.8 kW	CEE plug 16 AH

2. Controls

Switches and other controls for operating and monitoring the machine are described below.

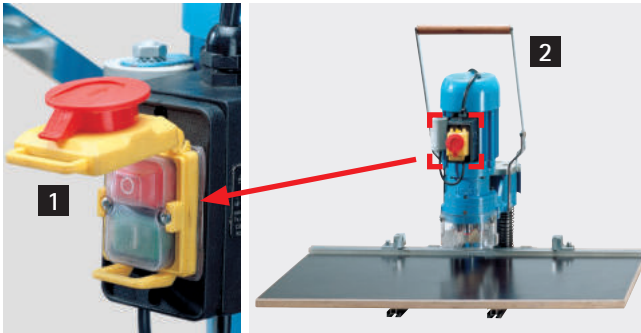

Fig. 3: Controls on the automatic drilling and insertion machine

Item	Designation	Explanation
1	Emergency stop button	Power supply ON / OFF
2	Hand lever	Start drilling

3. Setting



WARNING

Setup work may only be performed by qualified staff who, on the basis of their specialised training, experience and instruction, possess sufficient knowledge of

- safety rules,
- accident prevention regulations,
- guidelines and generally accepted codes of practice.

These qualified staff must be authorised to perform setting up work by the person responsible for the machine's safety.

4. Rating plate



NOTE

The rating plate is located on the machine.

The rating plate shows the following information:

	Manufacturer
	Address
	Type designation, machine numbers
	Year of manufacture
	Technical specifications (e.g. nominal pressure)

All country specific information, such as the depiction of the CE or UKCA mark, can be found on the type plate attached to the machine.

State all of the above details when requesting technical information and ordering replacement parts.

5. Safety guards

Separating protective guards complying with EN 953 are installed on the machine to protect staff from mechanical hazards.

Warnings / pictograms are also provided on the machine.



Fig. 4: Sliding guard at drilling spindles

6. Labelling

Area: entire machine

Warning of the risk of hands getting crushed

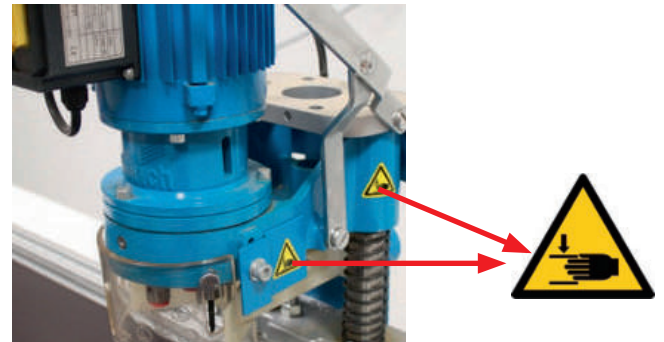

Fig. 5: Labelling – entire machine

Area: protective cap at drilling spindle

Warning of the risk of hands getting crushed

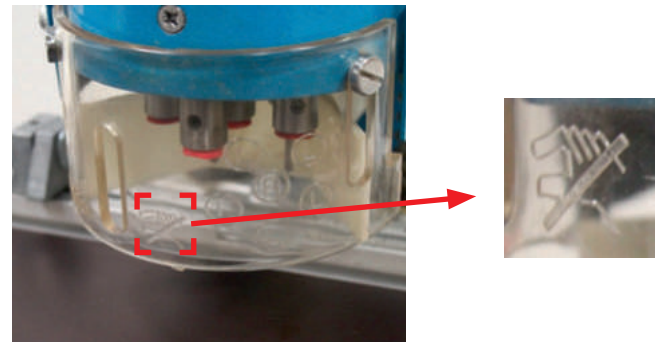

Fig. 6: Labelling – drill

Description of the machine

Area: motor / drive

Attention must be drawn to the need to wear appropriate ear protection.

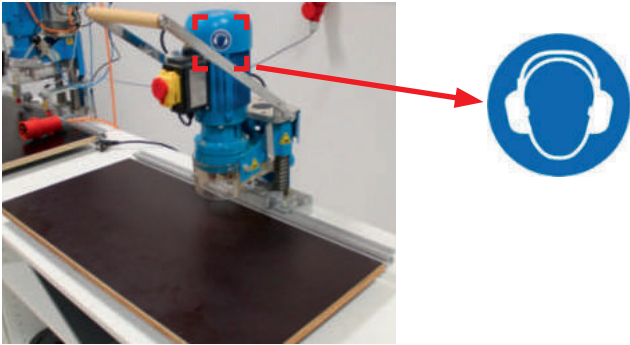

Fig. 7: Labelling – motor / drive

Transportation and Installation

5. Transportation and installation

- | | |
|--|----|
| 1. Transportation | 48 |
| 2. Internal transportation | 48 |
| 3. Checking delivery for missing items | 49 |
| 4. Dealing with shipping damage | 49 |
| 5. Site of installation | 49 |

1. Handling

The machine must only be transported and installed by companies / persons instructed / authorised to do so by the manufacturer or under the manufacturer's supervision.

After moving the machine, every part of it must be checked for transportation damage as possible harm may impair system operation and safety.



NOTE

To prepare transportation, please bear in mind the weight of the machine!

The machine weighs approx. 31.2 kg.

Transportation on fork lift truck or pallet jack:

If fork lift trucks or hand pallet jacks are used for loading or unloading, they must be in proper working order and suitable for carrying the weights that are involved.

Attention must always be paid to the centre of gravity of the item being moved!

During transportation, the machines must be properly secured; the load must be evenly distributed. Avoid jerky movements.

Set the machine down without bumps or jolts as well as in an upright standing position. Take immediate action to prevent these from being damaged by transportation vehicles and from tipping over. On unloading, handling and keeping the machine in temporary storage, treat it with the greatest possible care and protect it from the weather, impact of external force and from falling objects.



WARNING



Warning of suspended loads!

To relocate the machine, it must be lifted and transported. The machine can topple over and fall as a result of improper lifting and transportation.

Never stand under suspended loads!



WARNING

Warning of suspended loads!

While transporting the machine, no persons must be present on the machine or hang from it.

2. Internal handling:

To move the machine internally, only use trolleys of sufficient stability and load capacity. When handling, always be sure to avoid knocks and vibration. Provide protruding objects (motors, drag chains, wiring harnesses, hoses, cylinders) with effective protection from damage.

3. Checking delivery for missing items

Refer to the order confirmation or the list in this operating manual as well as the delivery note to ascertain what should be included. On receipt, immediately check to make sure a delivery is complete. Notify the shipping company making the delivery of any missing parts (notice of loss) and also immediately inform Paul Hettich GmbH & Co. KG.

4. Dealing with shipping damage

Immediately after arrival and unloading, thoroughly check the machine for any shipping damage, i.e. for externally visible damages (fractures, dents, kinks, cracks etc.).

Any suspected shipping damage must immediately be:

- reported in writing to the shipping company making the delivery (forwarder) and/or
- reported in writing to your own insurance company as well if the transportation risk was insured by the owner

5. Site of installation

An even standing surface with a sufficient load bearing capacity is essential for setting up the machine in a proper and safe manner. Any unevenness in the standing surface must be evened out by metal shims to ensure that the machine is not standing in a distorted manner.

The BlueMax Mini Type 2/6 comes in secure shipment packaging for safe transportation. A number of components must be installed to make the machine ready for operation. After installing the machine, it must be cleaned.

Secure the machine on a bench / base frame to be provided at the site of installation so as to prevent it from falling.



CAUTION

Risk of crushing!

Allow a space of at least 500 mm between moving machine parts and pillars, parts of the building, cabinets etc.!

Do not stand any laden pallets in this safety zone!

6. Start up

- | | |
|-----------------------------------|----|
| 1. General | 50 |
| 2. Safety check | 50 |
| 3. Malfunctions on start up | 51 |
| 4. Starting up for the first time | 51 |
| 5. Carrying out trial run | 51 |
| 6. Concluding start up | 51 |

1. General

The instructions described here are to be understood as minimum recommendations. Depending on operating conditions, they may need to be broadened in order to maintain the machine's working quality.

Servicing and maintenance work in specific disciplines (pneumatics etc.) must only be carried out by skilled persons trained in that particular discipline.

Observe the following safety advice!



WARNING

You could get crushed by moving parts if the machine is not shut down.

The machine must be depressurised and disconnected from the power supply before carrying out maintenance and cleaning work!



NOTE

Improper repair will result in damage to the machine!

Improper dismantling and assembly may result in property damage or consequential damage to the machine.

Therefore, when carrying out any removal or dismantling activity, always:

- mark parts that belong together
- mark or make a note of the position and point of installation
- remove and store assemblies separately

After carrying out maintenance work, always:

- check all screw connections to make sure they are tight.
Close and screw down all covers

As with starting up, listen for unusual noises and check to see if there is any heat buildup!

2. Safety check

The machine must only be put into operation by trained and qualified personnel.

Satisfy yourself that:

- installation, set up and servicing work have been completed in full and no persons are present in the danger zone, let alone working on it
- all safety guards / covers are in place
- the compressed air supply is ready for operation
- the controls are readily accessible

3. Malfunctions on start up

On start up, immediately switch OFF the power supply to the machine if:

- unusual operating noises can be heard
- the machine runs irregularly, oscillates or vibrates
- auxiliary units malfunction
- the motors consume too much power
- there are electrical faults
- tools are overheating



DANGER

Danger from electric shock!

Working on live components in the improper manner presents a danger to life!

Work on electrical equipment must only be carried out by authorised electricians!

Establish the cause of any malfunctions with the machine shut down and made safe and have it rectified by a qualified and skilled person trained to do so or eliminate the malfunction yourself if you are in possession of the necessary qualification.

Only switch the machine back on again once malfunctions / faults have been properly and completely rectified!

4. Starting up for the first time

Before starting up the machine for the first time, observe the following:



NOTE

The machine must only be put into operation for the first time by a person instructed / authorised to do so by the manufacturer / distributor or under the manufacturer's / distributor's supervision.

- Check to make sure the machine has been installed in accordance with the regulations specified!
- Make sure the machine stands firmly.
- Check to make sure that no foreign objects (tools, construction material etc.) have been left in the area of the machine from the assembly process.
- Check the hoses as well as the pneumatic system's hose connections.
- Check the safety guards for proper working order.
- Make sure that moving components can move without obstruction into the spaces they require and that the safety distances are observed.

5. Trial run with / without material

It is recommended to first carry out a trial run without material and drill bits to test all functions for proper working order. If all functions are working properly, fit the required tool.

Depending on connection, use the hand or foot switch for function testing.

Start a trial run without material. Afterwards, you should carry out a test with material.

Check work for correct results. You can start production if all settings are correct.

Preliminary conditions

- All of the necessary activation processes must have been carried out.
- The compressed air must be turned on.
- The machine must be set up for the relevant product.
- Make sure the machine is running smoothly and not erratically.
- The operator must always be informed about current work procedure.

6. Concluding start up

- After completing all servicing and set up work, make sure everything has been done properly
- Check all screws and connections for secure fit
- After completing the check, you should carry out a test using a component
- Start up may only be concluded once the machine is working properly
- Now switch the machine off and hand over production to the operator
- The operator must always be informed about the production settings currently in effect and given instruction on work procedure
- Production can now commence.



NOTE

Following servicing work, check all safety guards for proper working order.

Operation

7. Operation

1. Preparing machine	52
Drilling spindles	52
Drill bits	53
Connecting to extractor system	53
Connecting to the power supply	53
Accessories	53
Support block	53
2. Setting up (preparing for work)	54
Setting drilling depth	54
Edge distance	54
Pendulum stops	54
3. Operating	54
4. Installing Hettich hinges	55
Setting up	55
Drilling	55
5. Installing Hettich mounting plates	56
Setting up	56
Drilling	56
6. Installing Hettich connecting fittings	57
Setting up	57
Drilling	57

1. Preparing machine

The BlueMax Mini Type 2/6 is shipped in cardboard packaging. A number of parts and components must be installed to make the machine ready for operation. Once assembled, the machine must be thoroughly cleaned.

BlueMax Mini Type 2/6 base frame

Push work bench with sliding blocks onto the base profile and fasten the fence runner bracket in place on the base profile with clamping blocks and cheese head screws.

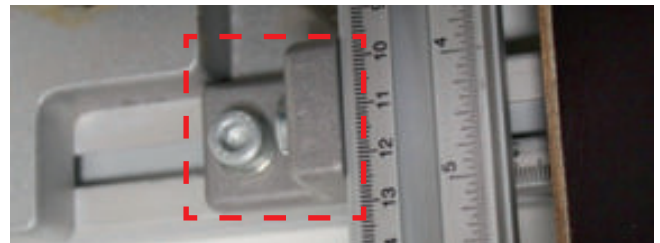

Fig. 8: Base frame with sliding blocks

Drilling spindles

The machine is delivered with drilling spindles ready mounted. Drilling spindles not needed must be closed off with the six blanks provided for unused chucks so as to prevent the threaded pins from working themselves out and provide effective protection from soiling.



Fig. 9: Drilling spindles

Drill bits

The machine is intended for use with solid carbide drill bits in a length of 57 mm and shaft diameter of 10 mm. Insert drill bits all the way, chucking faces turned towards the threaded studs, and tighten with the hexagon socket spanners. Pay attention to the spindle turning direction!

If necessary, adjust the length of the drill bits at the adjustment screws integrated in the drill-bit shaft.

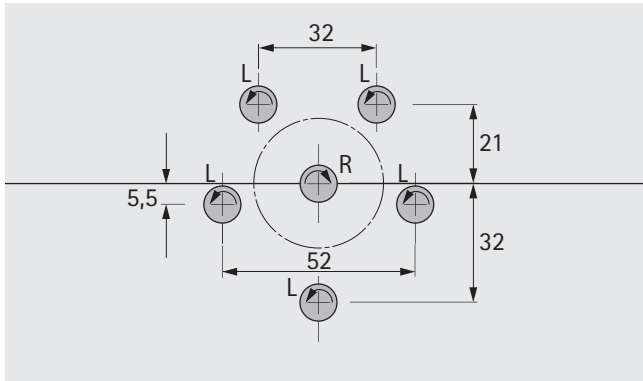

Fig. 10: Drilling pattern

Connecting to extractor system

Connect the machine to an extractor system. It is compulsory to use flexible, fire-retardant hose for connection to an extractor system.

Fit the extractor system's extraction hose to suction connector **1** and secure this in place with a hose clamp.

The extractor system must have an airflow rate of at least 20 m/s.

Extraction hose diameter: \varnothing 50 mm. Route extraction hose so as not to exert strain on the suction connector!

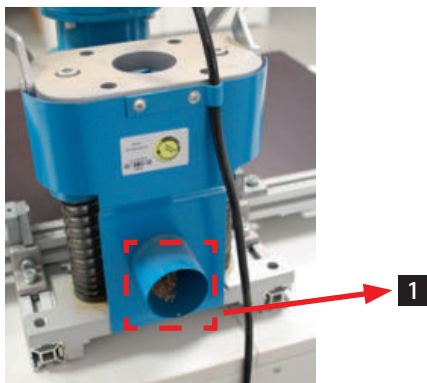

Fig. 11: Suction extraction connector

Connecting to the the power supply

Connect to the power supply using a 16-ampere plug.

Before you do, have a qualified electrician ensure that the socket is in proper working order.

Now connect the plug to the socket.

The machine is rated for a supply voltage of 400 volts. (other options are possible)

Use an appropriate plug compliant with the DIN VDE or IEC standard. An upstream fuse must be provided in the mains power supply system.

Check motor turning direction. The drive spindles must turn clockwise.

If the motor or spindles turns anticlockwise, you must reverse the phases in the plug.



Danger from electric shock!

Working on live components in the improper manner presents a danger to life!

Work on electrical equipment must only be carried out by authorised electricians!

Accessories

Scaled fence extension

Push half the bracket **1** onto the fence extension and half of it to the fence, then fasten in place with screws and clamping blocks **2**.

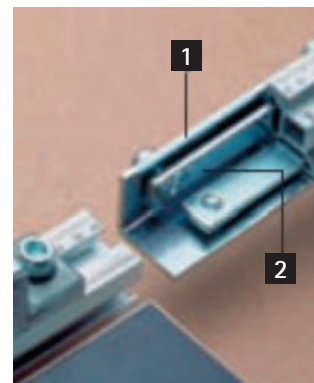

Fig. 12: Scaled fence extension

Support block

The support block is used for supporting the extension fence and for accommodating a broader work bench. To do this, fasten extension fence on the runner bracket using clamping blocks and cheese head screw. Slide work bench onto the profile by means of collar screws.

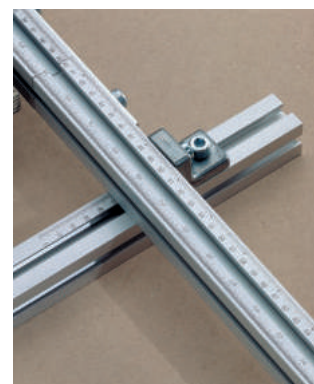

Fig. 13: Support block

Operation

2. Preparing for work



WARNING

Warning – Hand injuries!

Before resetting the machine, disconnect mains plug.

Setting drilling depth

Drilling depth can be changed by turning the threaded rod and locking it in place with the bottom knurled nut. One full turn alters the depth by 1 mm.

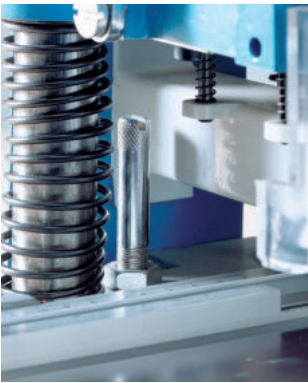

Fig. 14: Setting drilling depth



NOTE

Carry out trial drillings for each to establish the exact drilling depth.

Edge distance

The distance from the edge is set by sliding the fence along the scale. The setting is read at the marker on the front edge of the fence. To make the setting, both screws must be undone on the runner bracket and then tightened again (on both sides) after the setting has been made. The scale shows the edge distance in relation to the main spindle (centre of hinge cup).



Fig. 15: Edge distance



NOTE

Carry out trial drillings for each to establish the exact drilling depth.

Pendulum stops

The stop profile is factory set to 0 at the centre of the main spindle, making it possible to precision adjust stops to the left and right on the basis of the millimetre scale. After undoing the clamping screw, set stops to the required dimension and retighten.



Fig. 16: Pendulum stop



WARNING

Do not set any stops near the drilling spindles as otherwise serious damage could be caused, for example, to the drilling spindles and drilling unit.



NOTE

Carry out trial drillings for each to establish the exact drilling depth.

3. Operating

Switch on the BlueMax Mini Type 2/6 at the motor switch and press the hand lever down all the way to enable drilling. During operation, the motor can be stopped via the emergency stop.

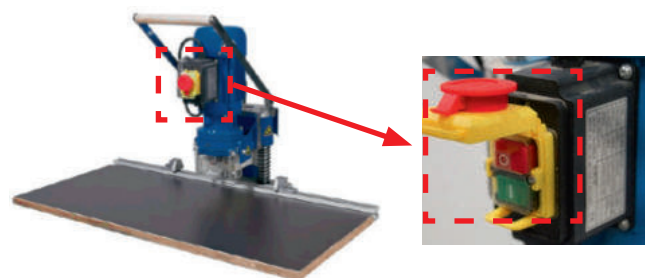

WARNING

Warning – Hand injuries!

While the machine is operating, always keep your hands away from the drill bit hazard zone.

4. Fitting Hettich hinges

Setting up

Clamp a 35 mm diameter, clockwise drill bit and two anticlockwise 10 mm diameter drill bits into three chucks (marked in red below) using an A/F SW 2.5 mm hexagon socket spanner. The remaining chucks must be closed off with blanks for unused chucks so as to prevent the threaded pin from working itself out and provide effective protection from soiling.

Set the drill depth stop and lock in place with knurled nut. One full turn alters depth by 1 mm. Carry out trial drillings for each to establish the exact drilling depth – see Section 2 – Setting drilling depth.

With a 6 mm Allen key, undo the fence screws and set the required distance from the edge on the scale (see Section 2 – Edge distance).

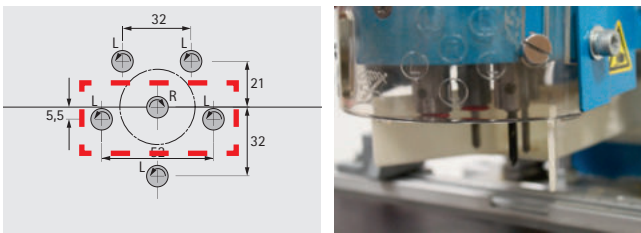

Fig. 17 Drilling pattern

Edge distance based on scale =
C dimension + 17.5 mm (half drilling diameter)
(Spindle distance to "0" point on scale)

Using the scale, set pendulum stops on left and right to the required dimensions – see Section 2 – Pendulum stops.

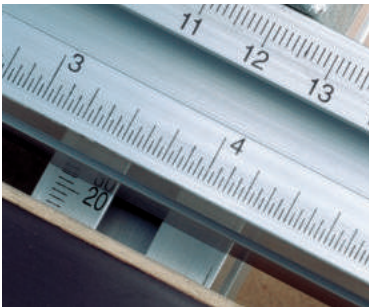

Fig. 18: Edge distance



WARNING

Do not set any stops near the drilling spindles as otherwise serious damage could be caused, for example, to the drilling spindles and drilling unit.



NOTE

Carry out trial drillings and check dimensions!

Drilling

Position the workpiece, push against the fence and pendulum stops. Switch on the BlueMax Mini Type 2/6 at the motor switch and press the hand lever down all the way to enable drilling. The Hettich hinge, for example, can now be fitted by hand.



WARNING

Warning – Hand injuries!

While the machine is operating, always keep your hands away from the drill bit hazard zone.



Fig. 19: Drilling

Operation

5. Fitting Hettich mounting plates

Setting up

Clamp a 5 mm diameter, anticlockwise drill bit into two chucks (marked in red below) using an A/F SW 2.5 mm hexagon socket spanner. The remaining chucks must be closed off with blanks for unused chucks so as to prevent the threaded pin from working itself out and provide effective protection from soiling.

Set the drill depth stop and lock in place with knurled nut. One full turn alters depth by 1 mm. Carry out trial drillings for each to establish the exact drilling depth – see Section 3.1.

Using an A/F SW 6 mm hexagon socket spanner, undo fence screws and set the required edge distance on the scale (see Section 3.2) or, with fixed stop fitted, move this up against the stop bolt and retighten.

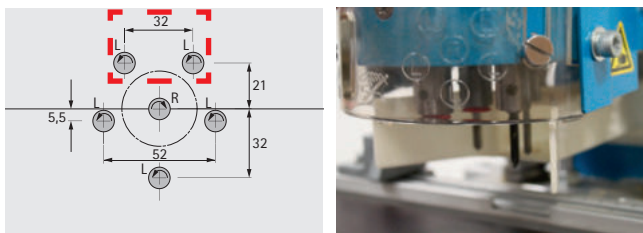

Fig. 20: Drilling pattern

Edge distance based on scale =
Dimension 37 (System 32) + 20 mm
(spindle distance to "0" point on scale)

Using the scale, set pendulum stops on left and right to the required dimensions – see Section 7.2 – Pendulum stops.



Fig. 21: Edge distance



WARNING

Do not set any stops near the drilling spindles as otherwise serious damage could be caused, for example, to the drilling spindles and drilling unit.



NOTE

Carry out trial drillings and check dimensions!

Drilling

Position the workpiece, push against the fence and pendulum stops. Switch on the BlueMax Mini Type 2/6 at the motor switch and press the hand lever down all the way to start drilling. The mounting plate can now be inserted by hand.



WARNING

Warning – Hand injuries!

While the machine is operating, always keep your hands away from the drill bit hazard zone.



Fig. 22: Drilling

6. Installing Hettich connecting fittings

Setting up

Using an A/F SW 2.5 mm hexagon socket spanner, clamp a 20/30 mm diameter, clockwise drill bit and a 10 mm diameter, anticlockwise drill bit into two chucks (marked in red below). The remaining chucks must be closed off with blanks for unused chucks so as to prevent the threaded pin from working itself out and provide effective protection from soiling.

Set the drill depth stop and lock in place with knurled nut. One full turn alters depth by 1 mm. Carry out trial drillings for each to establish the exact drilling depth – see Section 3.1.

Using an A/F SW 6 mm hexagon socket spanner, undo fence screws and set the required edge distance on the scale (see Section 3.2) or, with fixed stop fitted, move this up against the stop bolt and retighten.

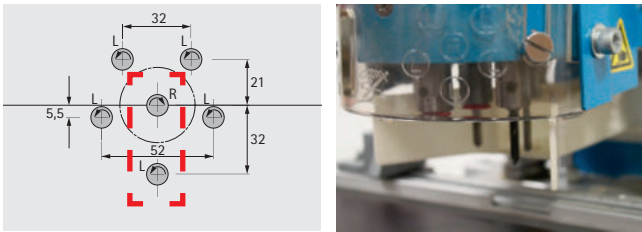

Fig. 23: Drilling pattern

Edge distance based on scale =
Dimension 9.5 (spindle distance to "0" point on scale)

Using the scale, set pendulum stops on left and right to the required dimensions – see Section 7.2 – Pendulum stops.



Fig. 24: Distance from edge



WARNING

Do not set any stops near the drilling spindles as otherwise serious damage could be caused, for example, to the drilling spindles and drilling unit.



NOTE

Carry out trial drillings and check dimensions!

Drilling

Position the workpiece, push against the fence and pendulum stops. Switch on the BlueMax Mini Type 2/6 at the motor switch and press the hand lever down all the way to enable drilling. The mounting plate can now be fitted by hand.



WARNING

Warning – Hand injuries!

While the machine is operating, always keep your hands away from the drill bit hazard zone.



Fig. 25: Drilling

Malfunctions / troubleshooting

8. Malfunctions / troubleshooting

1. General information	58
2. Servicing and maintenance	58
3. Labelling, information signs	58
4. Taking out of service	59
5. Disposal	59
Protecting the environment	59
Scrapping	59
Oil and oily wastes	59

1. General information



NOTE

Always first identify the cause of any malfunction.



WARNING

Safety regulations while identifying the source of malfunction and rectifying malfunction!

Observe the accident prevention regulations!

- In the event of a mechanical malfunction, make sure that the assembly jig is depressurised!
- Prevent the machine from switching back on again and attach a warning sign!

Machine malfunctions must only be rectified by qualified staff instructed to do so by the person responsible. In identifying the source of malfunction attention must be paid to the entire area surrounding the machine. The manufacturer must be immediately notified of any damage occurring during the warranty period.

2. Servicing and maintenance

- Check the safety guards every day for proper working order.
- Regular inspection of the electrical system in compliance with the VDE guidelines



WARNING

Risk of injury!

Servicing and maintenance work must only be carried out by instructed, qualified personnel.

Dust must be cleaned off the guide columns at regular intervals. Following prolonged periods out of service, the guide columns must be cleaned and lubricated with 2 – 3 drops of machine oil. A thin coat of lubricating grease must be applied to all drill-bit shafts before they are inserted into the chucks to facilitate insertion and removal.

The machine itself must be properly cleaned at regular intervals.

3. Labelling, information signs

Labelling/information signs must be

- cleaned with a cloth,
- checked for secure attachment and legibility,
- replaced if they are damaged.

4. Taking out of service

When taking the machine out of service, it must be disconnected from the compressed air supply to dissipate the residual or stored energy.



DANGER!

Even after the machine is switched off, cables in the control cabinets are still live

- Power supply cables
- Control cables to the power switch
- Undervoltage supply

Work on electrical equipment must only be carried out by authorised electricians!



WARNING

Risk of injury!

The compressed air supply must be disconnected by industrial mechanics or by persons of similar qualification.

5. Disposal

Dispose of the packaging in an environmentally friendly manner.



The BlueMaxMini type 3 contains components which must not be disposed of as household waste but as hazardous waste.

Under the European WEEE directive, electrical and electronic devices must not be disposed of with household waste. Their components must be recycled or disposed of separately because toxic and hazardous components can cause lasting damage to the environment if they are disposed of improperly.

On request, the manufacturer will provide details of the take back concept in effect.

Sort machine parts before disposal and dispose of them in an environmentally friendly manner.

Protecting the environment



CAUTION

The obligations prescribed in law with regard to avoiding waste and proper recycling / disposal must be followed during all work on and with the machines!

Particularly when carrying out installation, repair and servicing work, substances hazardous to water, such as

- lubricating greases and oils
- solvent based cleaning fluids

must not be allowed to pollute the ground or enter the sewer system!

These substances must be kept, transported, recharged and disposed of in suitable containers.

Scrapping

If the machine is ever taken out of service for good, the laws and regulations on disposal in force at that time must be observed and met.

At the time of final shutdown and disposal, it is necessary to dismantle and remove the entire energy supply system and dispose of the lubricating oils.

At the end of their useful life, machines must be disposed of by a specialist company qualified to do so.

It makes sense to check which materials can be recycled and then also do so.

Oil and oily wastes



CAUTION

Oil and oily wastes are a huge potential threat to the environment. This is why they are disposed of by specialist companies.

Channel these wastes into the company's internal disposal department which will then pass them on to specialist companies.

Replacement and expendable parts

9. Replacement and expendable parts

Please note that the manufacturer's declaration or declaration of conformity given by Paul Hettich GmbH & Co. KG as manufacturer will lose its validity if non approved replacement parts are installed.

2101	Boring block
2102	Drilling unit cover
2103	Auxiliary spindle with chuck (5 each)
2104	Main spindle with chuck (1 each)
2105	Pinion z = 21 (4 each.)
2106	Pinion z = 32 (2 each.)
2107	Guide column
2108	Base plate
2109	connecting bracket
2110	Hexagon nut GB 6170 M 12x1 galvanised
2111	Drill depth stop M 12x1
2112	Guide plate
2113	Work surface 400 mm x 800 mm
2114	Fence 800 mm
2115	Base profile 465 mm
2116	Guide screw M 6x12
2117	guard
2118	Flat head screw with slot and dog point
2119	Fence bracket assembly
2120	Blanks for unused chucks (76497)
2121	Cable grip HM (type 2/6)
2122	Suction extractor funnel assembly (without mounting)
2124	Extractor metal cover (without mount)
2127	T-slot screw
2128	Hexagon nut
2130	Self-tapping screw GB 818 – M4x10 (3 each)
2131	Washer 4
2151	Deep groove ball bearing 6000 -2RS
2152	Bushes
2154	Compression spring for type 2/6
2156	Pendulum stop assembly (061 285)
2159	Cross head countersunk screw M 5x8
2160	Cheese head screw with hexagon socket M 10x30 (2 each)
2162	Cheese head screw GB 70 – M 6x10
2163	Cheese head screw GB 70 – M 8x10

2164	Rhomboid nut M8
2165	Threaded stud GB 80 M5 x 4
2167	Cheese head screw GB 70 – M 6x12
2168	Cheese head screw GB 70 – M 8x20
2172	Sealing ring
2173	Threaded stud SM 15/64x28x5 and SM 15/64x28x7
2174	Cheese head screw GB 70 – M 10x35
2175	Spring washer GB 958 – A 10 each
2179	Cylindrical pin GB 119 – A D.4x16
2180	Washer 8
2181	Left-hand cover
2182	Right-hand cover
2183	Runner O-ring 3x1.5
2184	Threaded stud with hexagon socket M 5x8
2185	Shaft for trapezoidal block (2 each)
2186	Cheese head screw with hexagon socket M 8x16 (6 each)
2187	Threaded stud GB80 M 5x6 (2 each)
2188	Angled element (2 each)
2189	Trapezoidal block (2 each)
2320	Linkage system for cranked hand lever
2321	Handle rod
2322	Pan head screw GB 70 M 8x6
2353	Countersunk wood screw GB 922 – 6x25
2530	Motor mount
2551	Motor
2552	BoWex coupler assy
2553	Feather key for coupling GB 1096 – A 3x6
2554	Cheese head screw GB 70 – M 6x16
2555	Cross head self-tapping cheese head screw ST 3.5x16
2556	Switch
2557	Rubber sealing ring for switch
2558	Cross head cheese head screw
2559	Strain relief
2560	control console
2561	Rubber sealing ring for control console

Exploded drawing

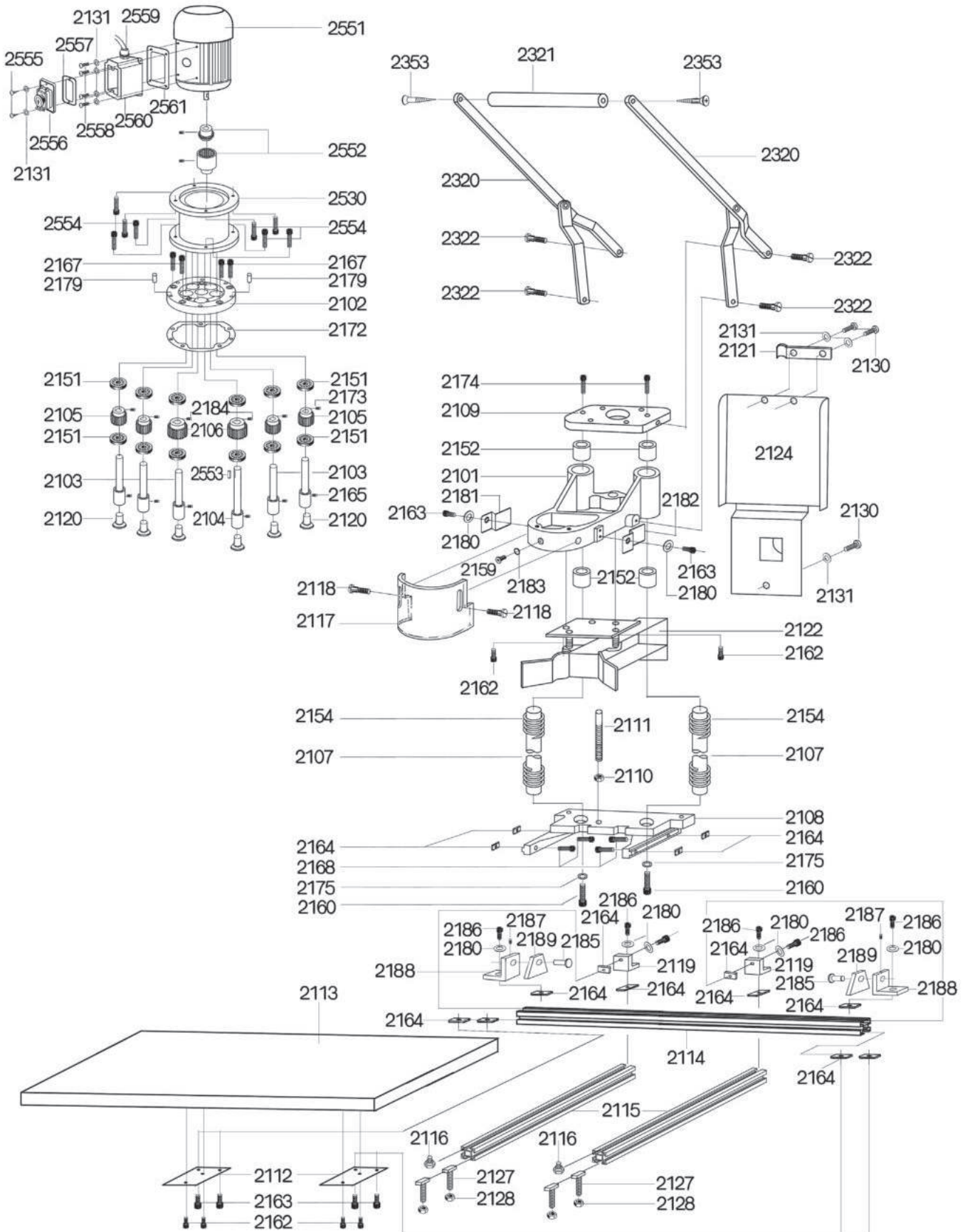

en