

Reflections.
REFLECTIONS

SPLASHBACK + WALL PANEL
SIMPLE DESIGN, UNLIMITED IDEAS

INSTALLATION GUIDE

General Information

Reflections Splashback + Wall Panel is a highly advanced panel ideal for any vertical applications. Perfect as a kitchen splashback or in your shower recess, Reflections offers an affordable and DIY alternative to glass. Easily installed, Reflections can be used for any indoor or outdoor renovations and can be applied directly on top of an existing tile wall. With a smooth, grout free finish, this panel requires minimal maintenance and is easily cleaned with a slightly damp microfiber cloth.

Recommended product applications

- Kitchen splashback
- Shower/Bathroom splashback
- Vanity splashback
- Laundry splashback
- Alfresco kitchen splashback
- Feature wall

Care & maintenance

Reflection Splashback + Wall Panel is easy to clean using a mild detergent and a soft microfiber cloth. Simply wipe off cooking oils and food splashes.

- DO clean the surface regularly
- DO NOT use abrasive cleaners or scrubbing pads
- DO NOT attempt to clean the surface if it is hot
- DO NOT rub metallic or sharp tools against the surface
- We recommend the De-Solv-It product to remove older and more stubborn stains

Technical properties

Reflections is composed of a flame retardant mineral fibre composite core, wedged between two 0.5mm sheets of aluminium. Reflections offers a flame retardant surface suitable for use behind freestanding or bench mounted gas, electric and induction cooktops. For gas cooktop installations, Reflections is Australian Lab Certified to be installed with a minimum clearance of 110mm to the edge of the REAR burner. However, each appliance manufacturer has specific installation requirements so we therefore also recommend that you refer to your cooktop installation specifications. Reflections is also 100% waterproof and UV resistant and is suitable for use in high-moisture areas such as a shower recess or behind a sink and in outdoor applications.

Product Specifications

Total Thickness	4mm
Nominal Weight	7kg/m ²
Flame retardant	Compliant with: AS/NZS 1530.3 - 1999

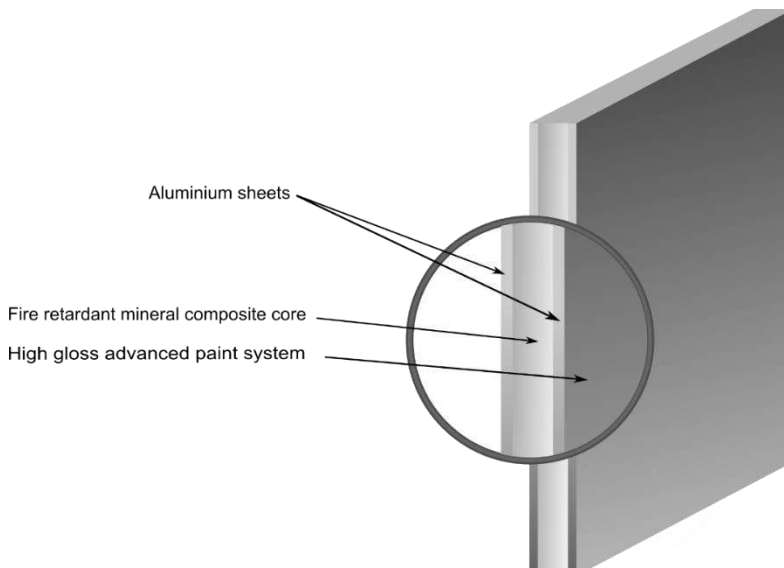

Warranty

Reflections Splashback + Wall Panel has a 7-year limited warranty whether you install it yourself or use a professional installer. Warranty is only valid if Reflections Splashback + Wall Panel is installed and fabricated according to this Installation Guide.

Important Information



Please read before you start

All Reflections sheets have protective film on both sides of the panel to prevent damage during storage, transport and handling. Keep the film on the chosen decorated side of the panel until instructed to remove it at the end of the installation process.

Storage

Always store the wall panel stacked horizontally to avoid bowing of the sheet.

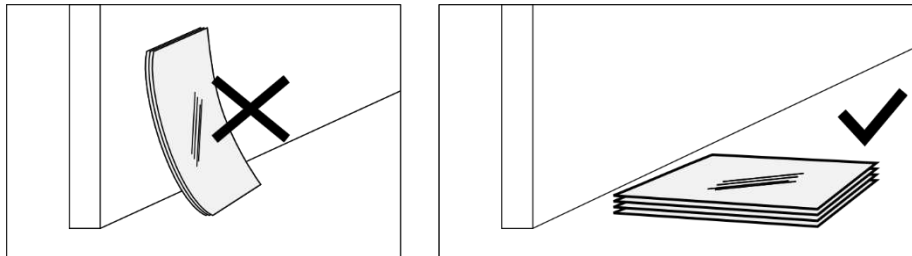

Preserving the high gloss coating during the installation process

Do not remove the protective film covering the panel until the installation is completed.

Do not use highly abrasive or alkaline detergents.

Avoid scratching panels with any sharp tool or object.

Safety

Always wear the appropriate protective equipment (clothing, footwear, and eyewear) during the installation process. The panels may have sharp edges, always wear gloves while manipulating the panels.

Larger sheets can be heavy (e.g. a 3100mm x 1000mm sheet weights approximately 21.7kg). Get assistance for lifting and handling larger sheets.



Sheet Inspection

Please inspect Reflections Splashback + Wall Panel upon reception for any visible sign of damage during transit or due to handling. Make sure that the protective film is intact on the chosen decorated surface and is free from drag marks or deep scratches.

Tools & Equipment

Conventional hand tools are ideal for the fabrication of your splashback. The installation of Reflections panel may demand some or all of the following items depending on your installation requirements:

Measuring

- Measuring tape
- Lead pencil
- Carpenters square

Cutting

The following equipment is suitable for cutting Reflections panels:

- Circular saw with fine tooth carbide tipped blades for aluminium or plastic use
- Panel or table saw with aluminium carbide blade
- Hand router using high speed TC blade
- Hole saw or drill using HSS drill bits
- Jigsaw
- Fine and medium grit sandpaper and sanding block or power planner

Installing

- Silicone caulking gun
- Neutral cure silicone adhesive (e.g. Sikaflex 11FC)
- Soft flexible spatula
- 12.5mm minimum width rubber based adhesive masking tape (e.g. 3M Scotchtape 4008)
- Personal protective equipment (eye, hands, hearing, footwear, clothing)

Cutting Reflections sheets

Reflections Splashback + Wall Panel is best fabricated on a solid work platform (e.g. bench or stable board).

Always clamp the sheet to a sacrificial board to minimise vibrations and ensure stability of the panel during the cutting process.

Notes on saw cutting

Place Reflections panel following the below directions according to the cutting tool you are using:

Tool	Cutting direction	Place the chosen decorated face of the panel:
Circular saw	UPWARD	DOWNWARD
Table saw	DOWNWARD	UPWARD
Jigsaw	UPWARD	DOWNWARD
Hole saw/Drill	DOWNWARD	UPWARD

Table 1 – Notes on saw cutting

Cooktop Installation Recommendations

For all bench mounted cooktops (i.e. electric, induction & gas cooktops) – we recommend installing Reflections Splashback + Wall Panel with a minimum 20mm set back (c.f. Figure 1) from the rear edge of the cooktop. This is to preserve the surface of the panel from the impact damage due to oversized cooking pots.

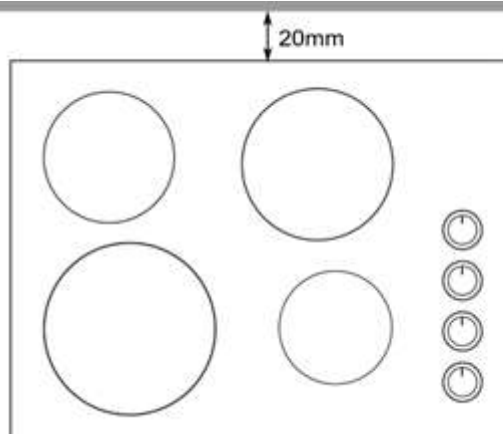

Figure 1 – All cooktops recommended distance from Reflections

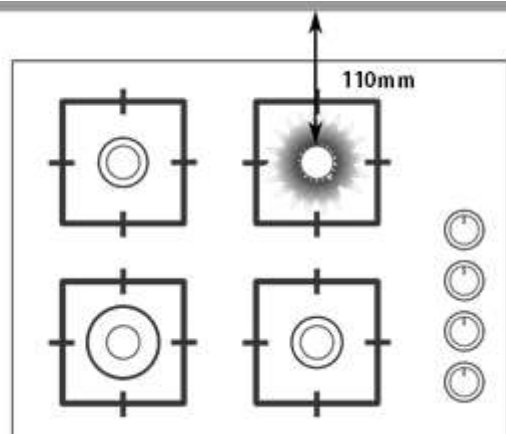

Figure 2 – Gas cooktops mandatory clearance from burner

STEP-BY-STEP INSTRUCTIONS

1. Area Preparation

Make sure that all fittings allow for the thickness of Reflections panel and decorative trims if applicable (cf. Figure 4). If you are using Reflections behind a cooktop, please refer to page 3 of this guide for installation clearances. The wall area must be dry, clean and free from major damage, crumbling plasterboard or grease. Any holes larger than 100mm across must be patched or filled (c.f. Figure 3)

Covering an existing surface (Tiles)

Reflections panel can be used to cover an existing tile wall. Ensure that the surface of the tiles is smooth and clean and that the tiles are securely attached to the wall.

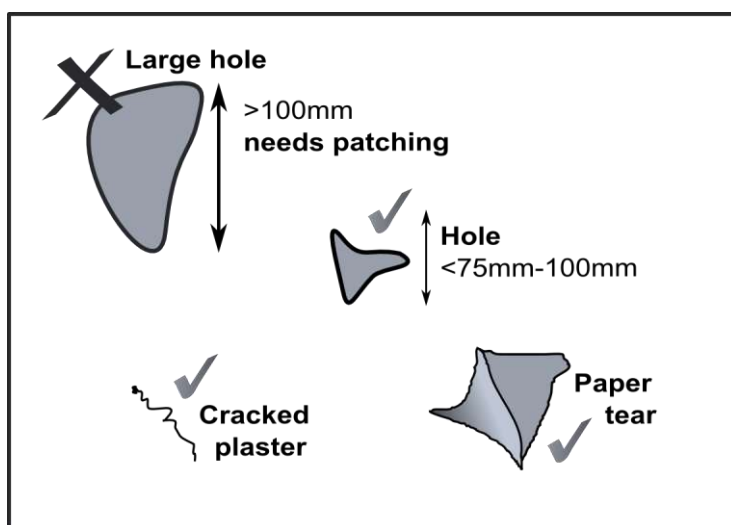

Figure 3 – Surface preparation

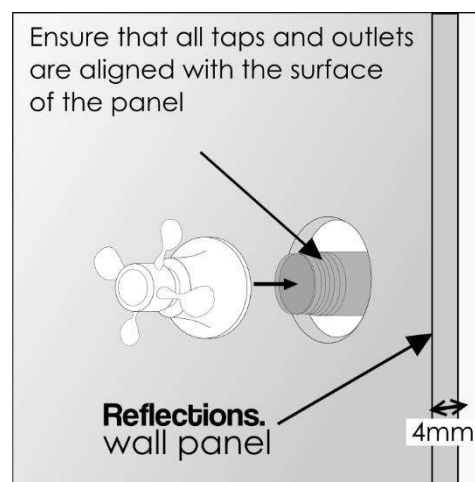

Figure 4

2. Measure

Take your measurements with precision to the millimetre.

Protect the wall panel and place it face down on a clean surface. Remember: do not remove the protective film until the splashback has been fitted to the wall.

Report your measurements onto the back side of the wall panel.

Make sure that the panel is lying on a surface free of sharp or abrasive tools or objects to prevent scratches.

3. Cut and fit

Refer to Table 1 and place the face of the panel upward or downward according to the cutting tool used. Cut and fit your panel to your measurements with:

- Jigsaw for all the cuts
- Circular saw to groove all straight lines.
- Cylinder saw and drill for all outlets and power point fit outs

Notes on Saw Cutting:

- Remove cutting chips from Reflections carefully after cut, to avoid dents during storage and assembly.
- Sharpen or replace the saw blade when it becomes dull. Dull blades will result in a large burr or distortion at the cut edge.

4. Cut out all electric plugs and all pipe outlets

Measure the horizontal and vertical axis of the plug/outlet

Report the measurement onto the reverse side of the panel

Pierce a hole with the drill to introduce the blade of the jigsaw

Cut out using the jigsaw or cylinder saw

We recommend licensed electrical contractors carry out all electrical work.

5. Dry test

Apply the wall panel against the wall without any adhesive to test its positioning. Adjust if necessary and try again.

6. Remove the protection film

Take off the protection film from the reverse of the wall panel.



Warning! Do not take off the protection film from the front side of the panel.

OPTIONAL STEP: Reflections Decorative Trim

If you have chosen to use Reflections Decorative Trims, place a bead of silicone along the top edge of the panel and then place the trim cut to size on top of the splashback. Repeat the operation for the side(s) of the panel if required before proceeding to step 7.

7. Apply the silicone and/or the adhesive

Apply double sided tape vertically to the panel every 400mm (c.f. Figure 5).

This is to hold the panel in place while the silicone adhesive dries.

Apply the silicone with the caulking gun in an S-shape pattern. Do not make circles with the silicone to allow the air to come out.

Add another bead of silicone around the cut outs

8. Apply the panel against the wall and seal

Place the panel against the wall applying even pressure across the panel. Apply a silicone cure between the bench top and the splashback to avoid any moisture leakage. Also seal the edges of the splashback if you are not using Reflections Decorative Trims. Remove excess silicone before removing the protective film from the panel in one long stroke before the silicone dries for a clean finish.

“BUTT JOIN” Technique

Where more than one panel is needed to cover the length required, we suggest to simply butt join two sheets for a visible but minimal joint line between the sheets. This will not affect the properties of Reflections panel.

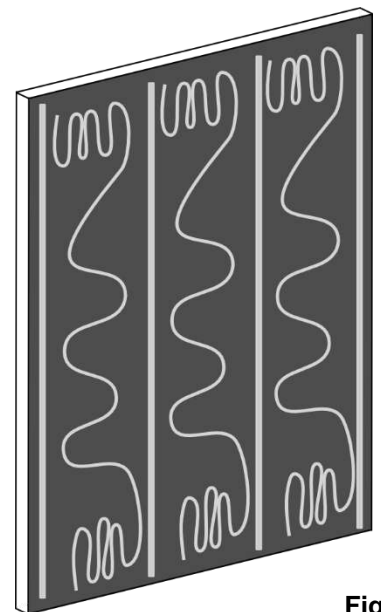
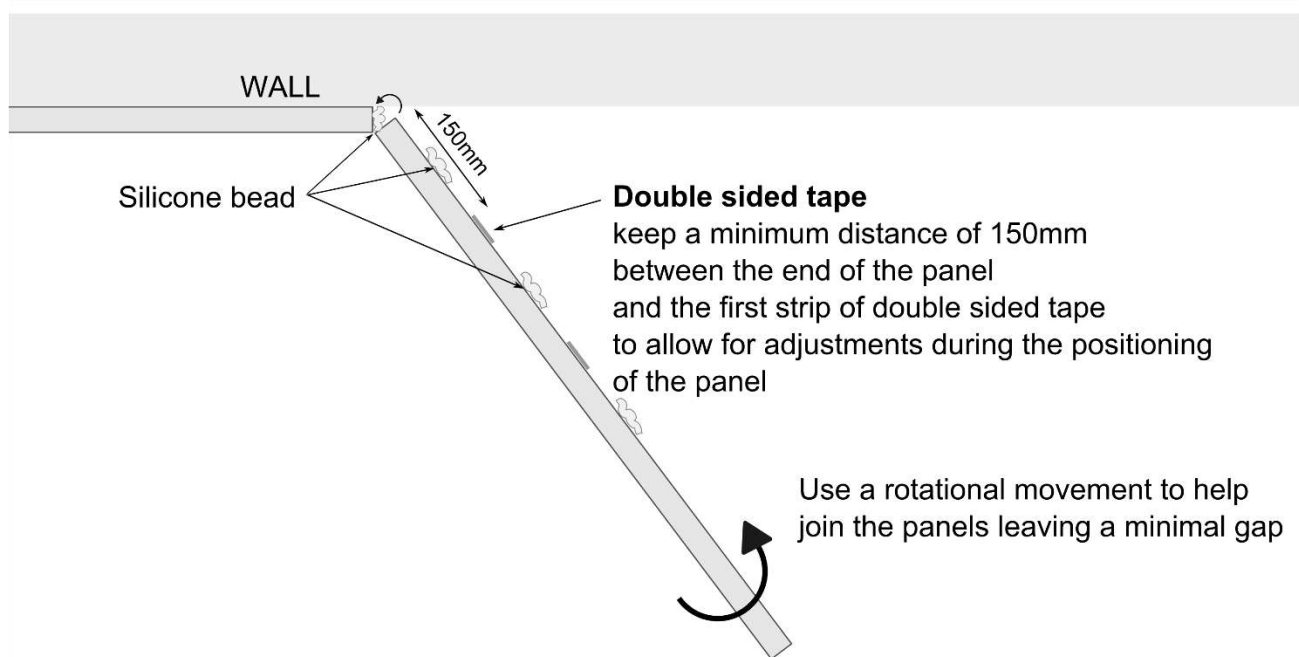

Figure 5



**Please note: the distance of the first strip of double sided tape may vary depending on the size of the panel. Use a distance appropriate to allow for adjustments during fitting.*

Distributed by
McRoberts Agencies Pty Ltd
ABN 50 143 962 921

May 2024

Customer Service Line (Monday to Friday, 7.30am to 2.00pm) 1300 721 264

NOTICE. While every precaution has been taken in the preparation of this document, the publisher and the author assume no responsibility for errors or omissions, or for damages resulting from the use of information contained in this document. In no event shall the publisher and the author be liable for any loss of profit or any other commercial damage caused or alleged to have been caused directly or indirectly as a result of any person relying upon any information contained in this document.

All work carried out by any user of this document on any Reflections splashback and panel must be done in accordance with all laws and regulations relating to that work and the panel, and including, but without limitation, occupational health and safety laws and laws relating to the protection of the environment.