

Prime Undermount – Installation Guide

- Primary material: zinc plated steel
- 30kg load capacity
- Tested to 50,000 cycles
- Full extension runners
- Synchronised soft closing action
- 6 way adjustment
- Adjustable opening & closing strength: +25%



Available in:
300mm, 350mm, 400mm, 450mm, 500mm & 550mm

Installation dimensions

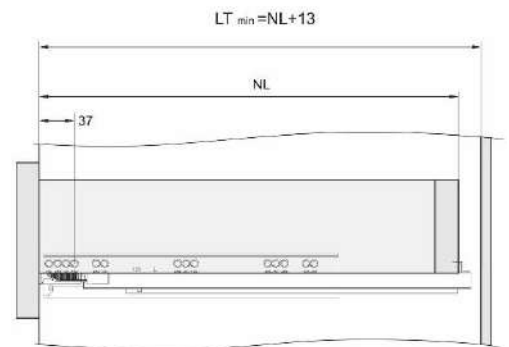
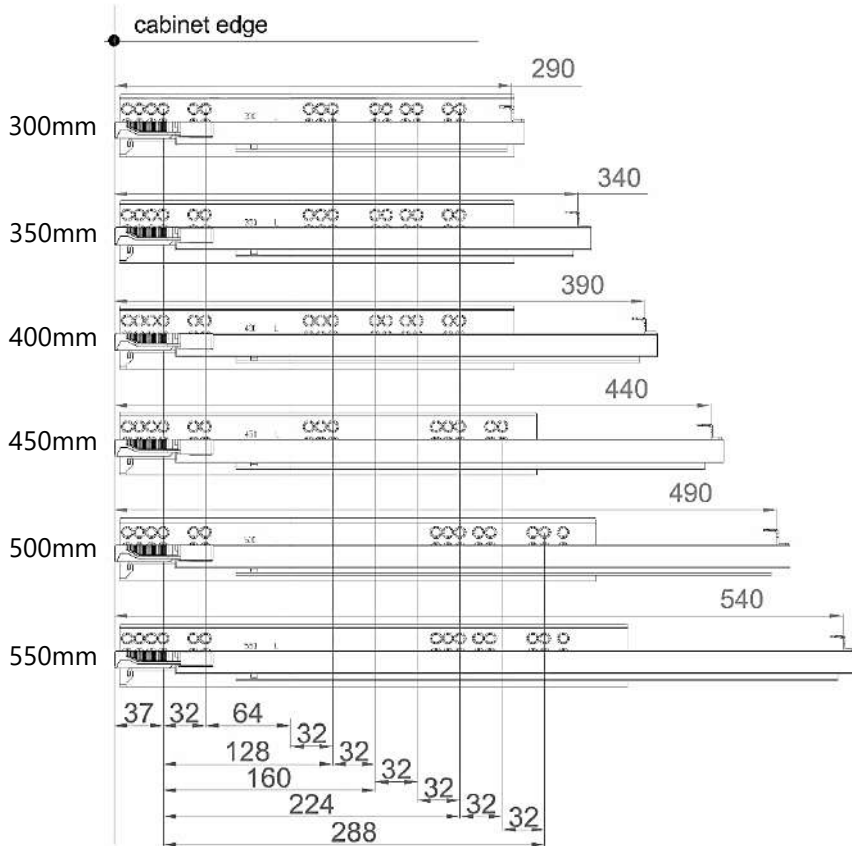

Standard drawer

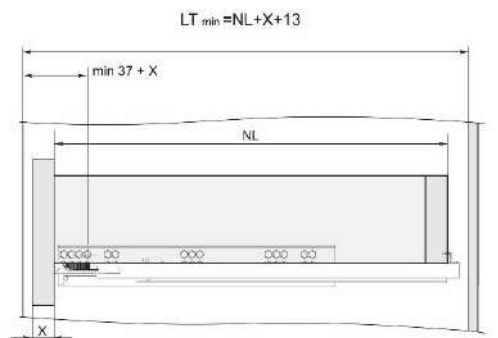

Built-in drawer

LT - Cabinet inner depth
NL - nominal slide length

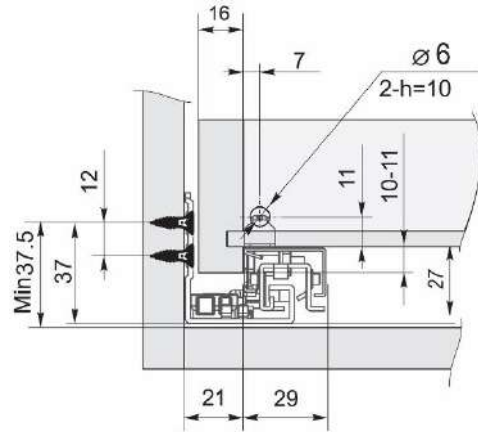
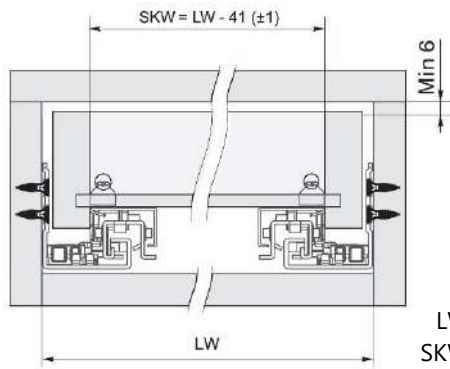

1. Install the slides on the cabinet

2. Install left/ right handle in the front of the drawer

3. Install the drawer on the slides, slide hooks insert into the pre-drilled holes on the drawer back panel

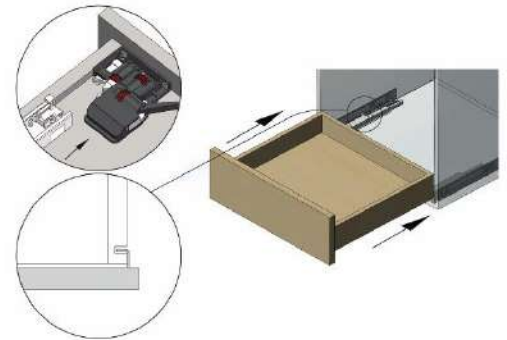
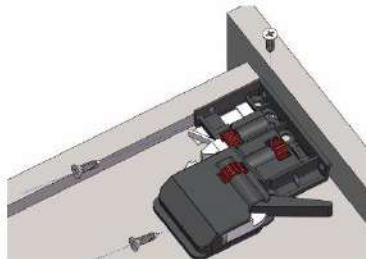
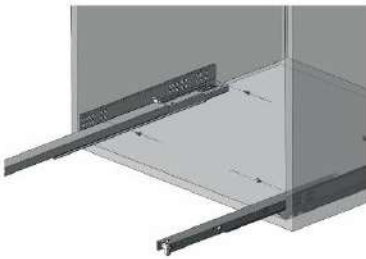

4. Adjust the front panel with plastic wheel on the handle

4.1 Front and back adjustment ±2mm.

4.2 Left and right adjustment ±2mm.

4.3 Up and down adjustment +3mm.

5. Adjustable opening and closing mechanism:

When the drawer takes more than 20kg, adjust the eccentric screw on the damper, max 25% more strength will be applied, so that make the movement smooth.

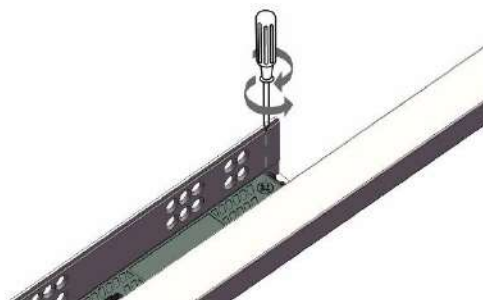
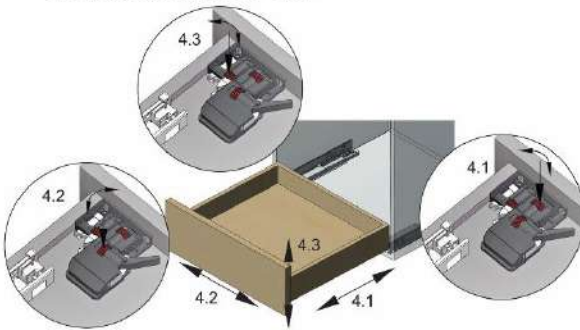

6. Push the handle lever to unlock the drawer, then pull out the drawer

